

wheelie bin covers

assembly instructions

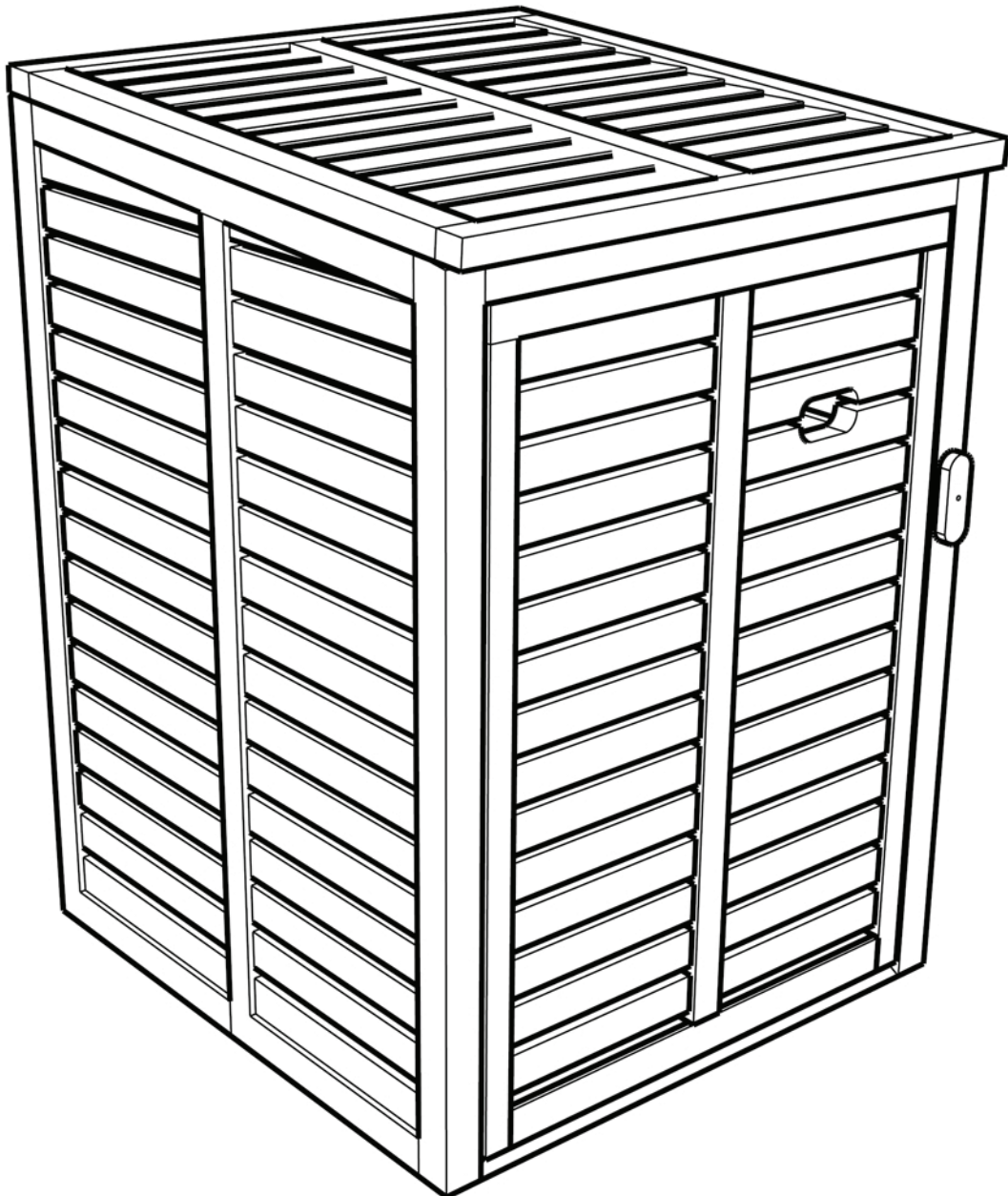

www.wheeliebincovers.co.uk

Thank you for purchasing this Wheelie Bin Cover. For further information on this product, please visit our website: www.wheeliebincovers.co.uk

Whats included in the box:

x12 Large Screws



x25 Small Screws



Door

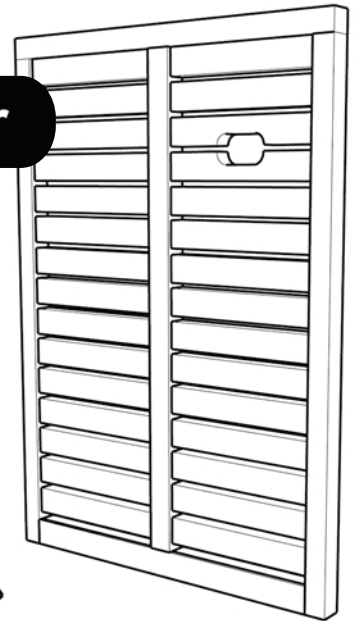

Lid

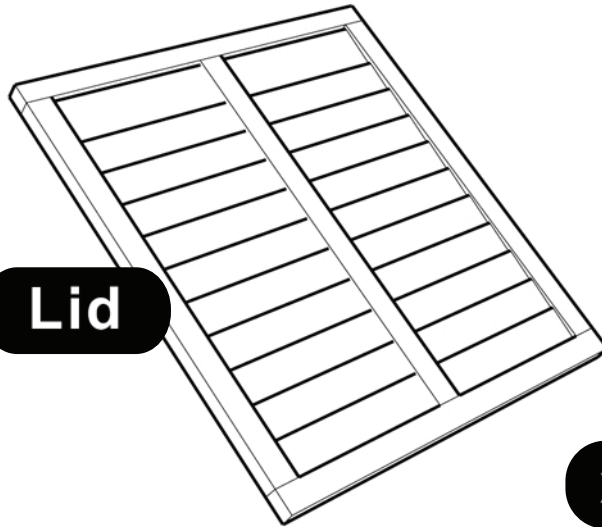

Top Support

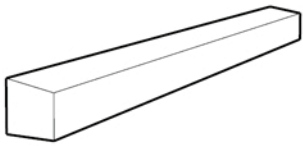

Bottom Support



Door Catch

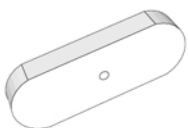

x2 Side



Back

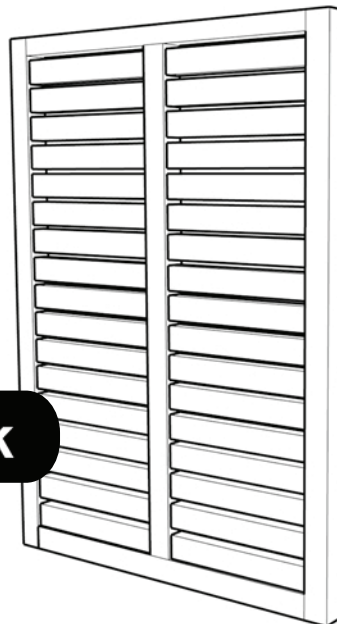

Chain



* You will need a phillips screwdriver and a hammer.

* Two people recommended to assemble this item.

Step 1:

Position BACK upright and align one SIDE. Secure together using 4 LARGE SCREWS.

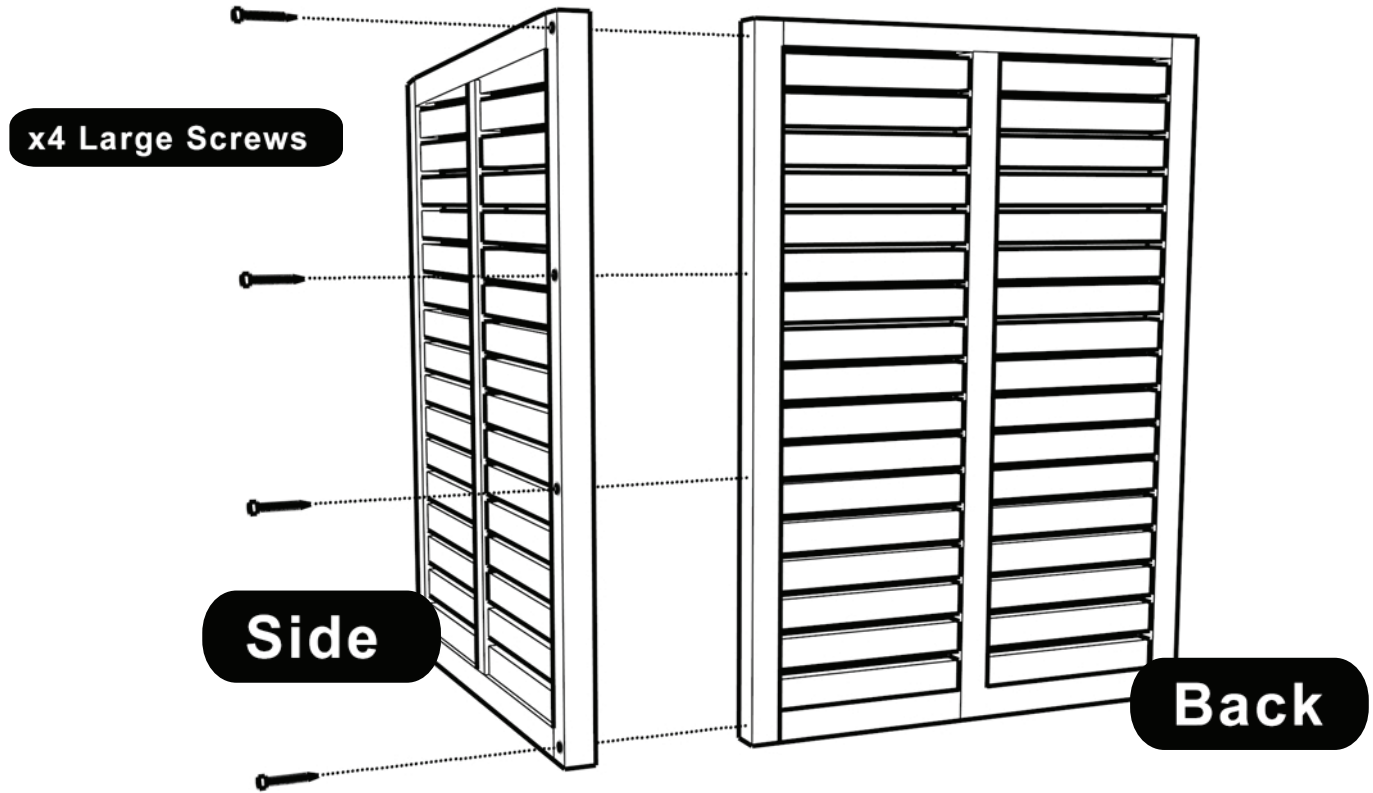

Step 2:

Repeat with other side.

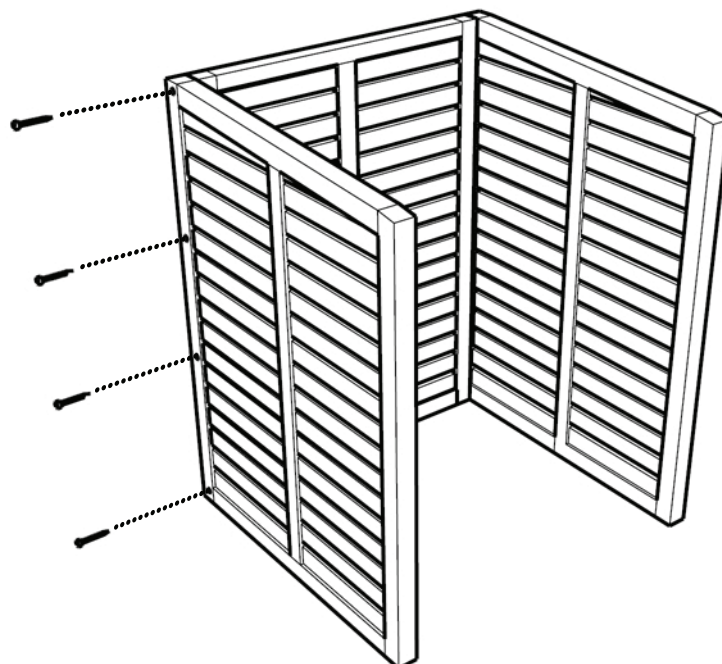

Step 3:

Attach TOP SUPPORT using 2 LARGE SCREWS.

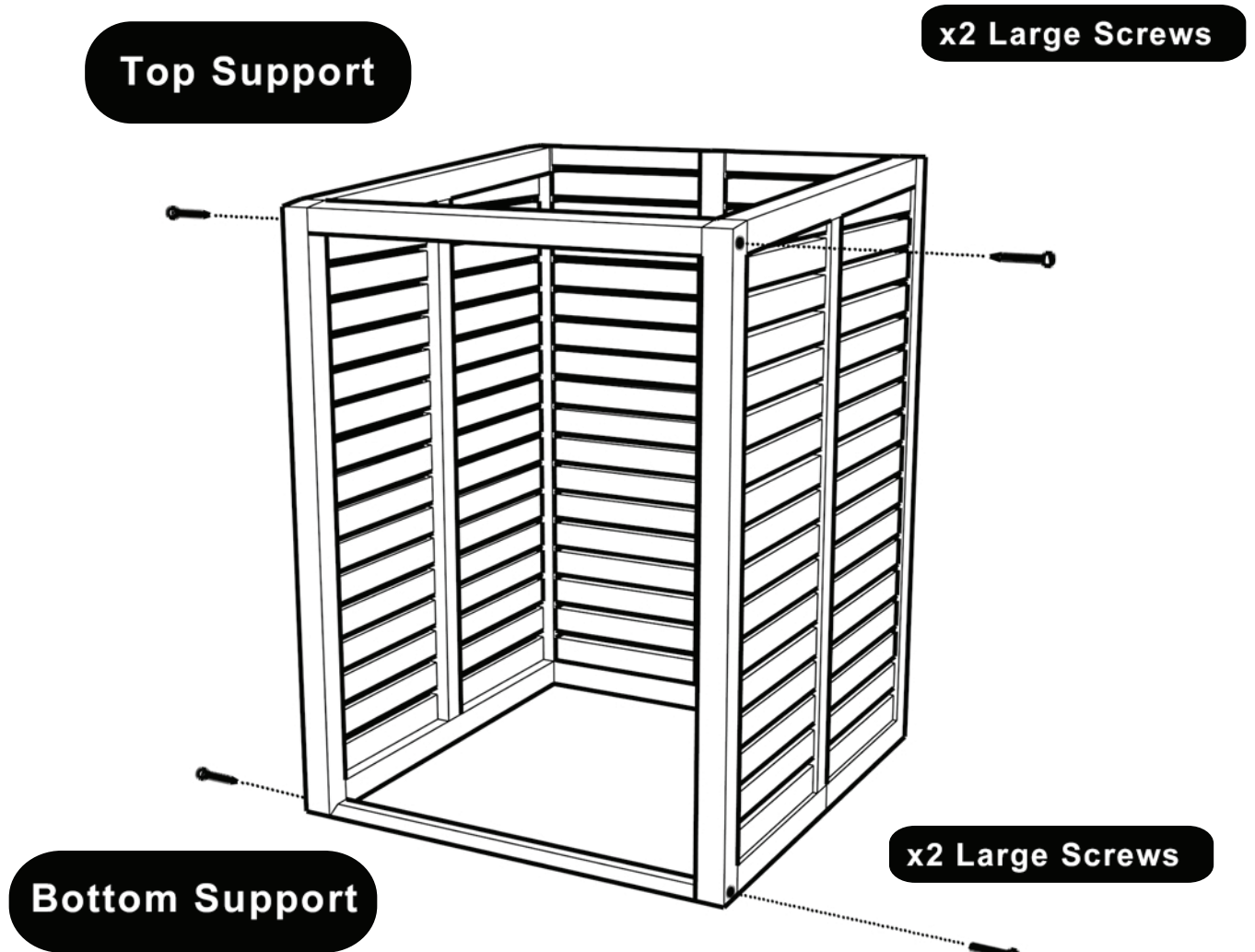

Step 4:

Attach BOTTOM SUPPORT using 2 LARGE SCREWS.

Step 5:

Attach FRONT DOOR, securing the hinges with 3 SMALL SCREWS in each hinge.

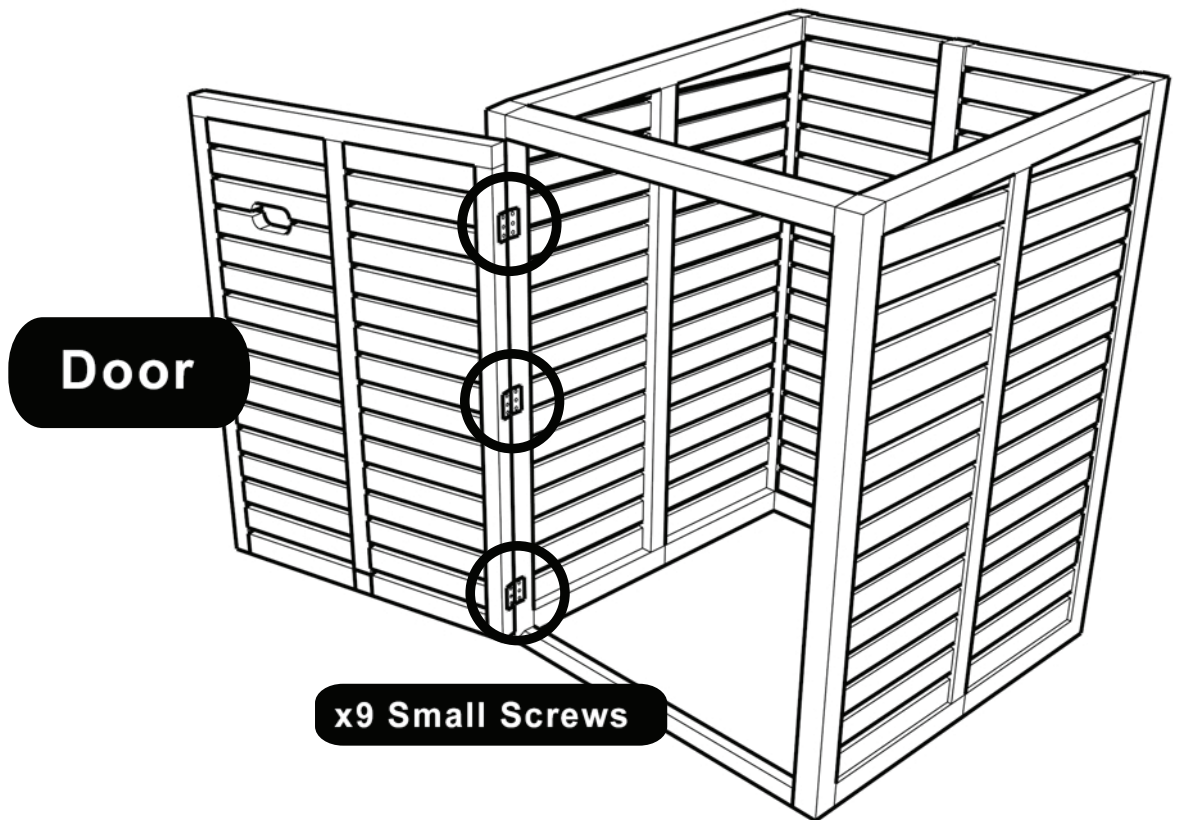

Step 6:

Attach LID securing two hinges with 3 SMALL SCREWS in each hinge.

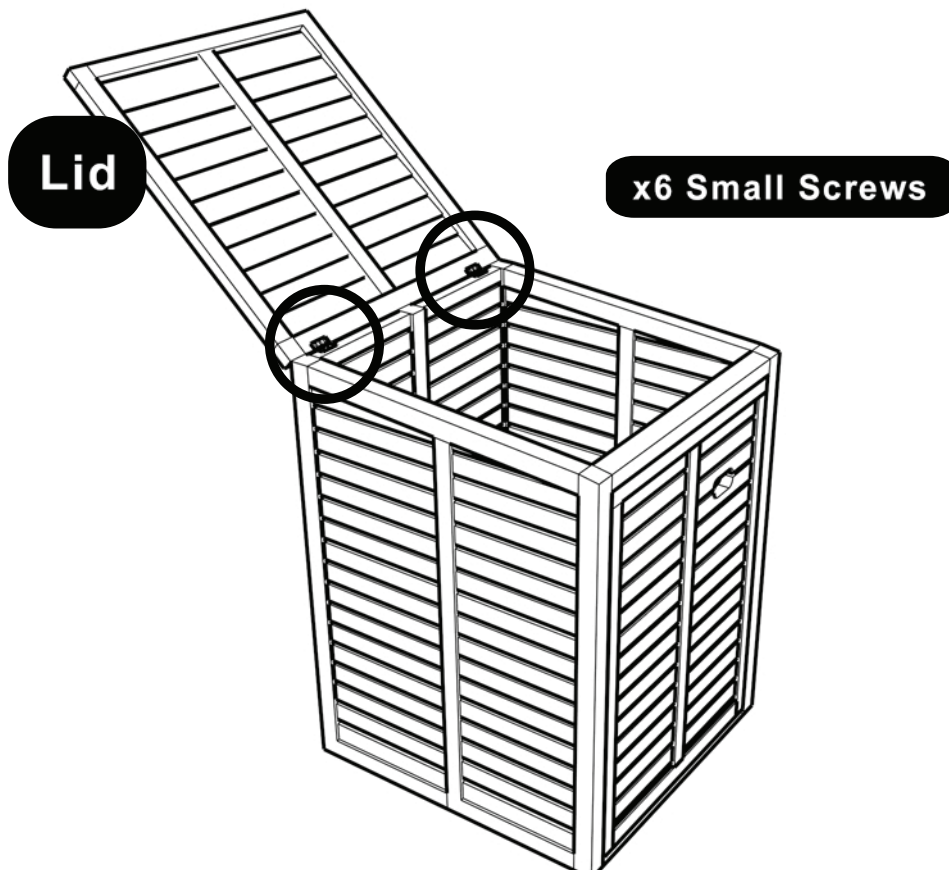

Step 7:

Screw DOOR CATCH on front of wheelie bin cover to opposite side from hinges, using 1 SMALL SCREW in preferred position.

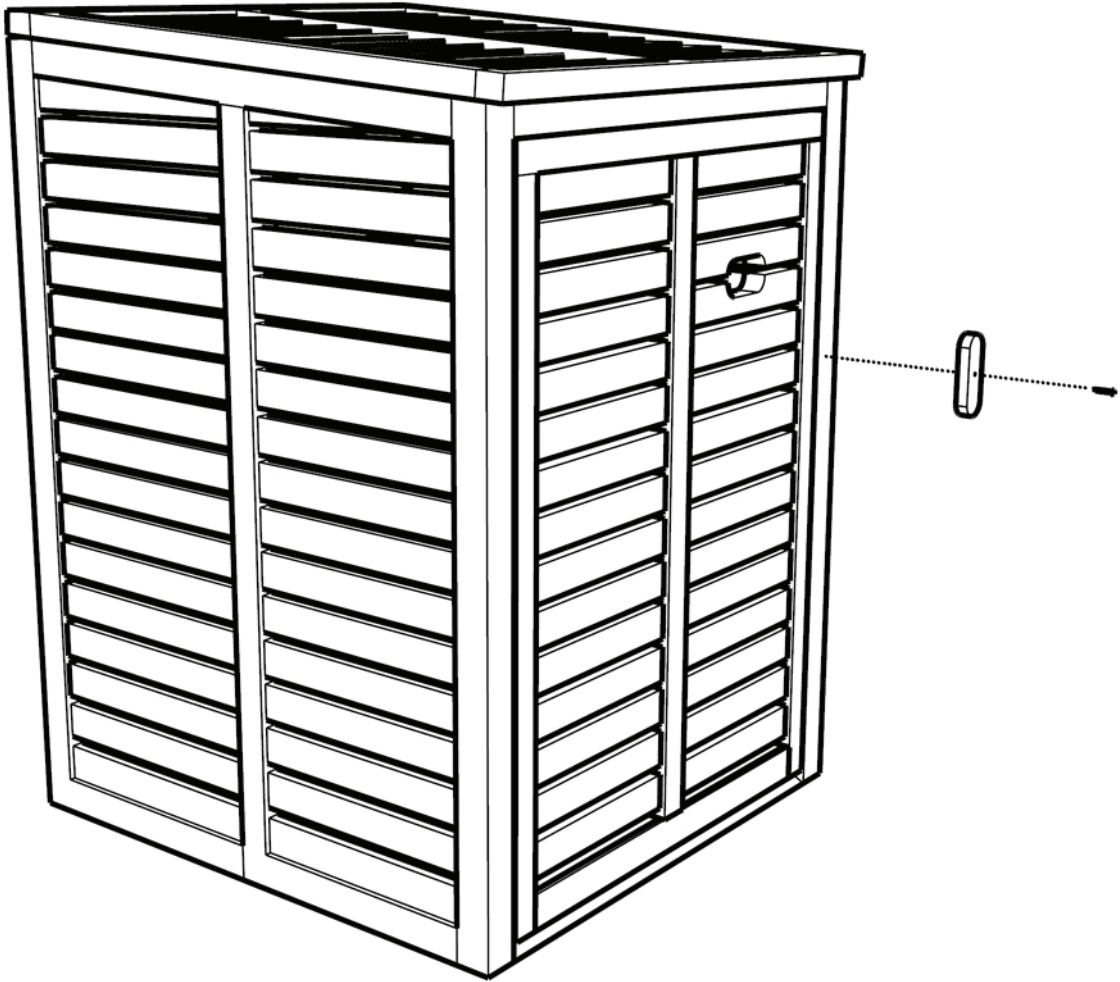

Step 8:

Using small hook provided on top left side of LID, attach CHAIN. This can be used to thread through handle of your wheelie bin to open bin lid as LID is lifted.

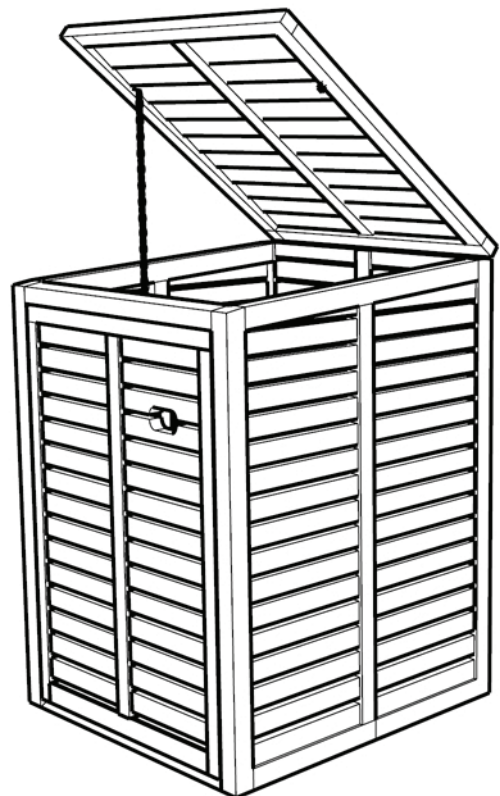
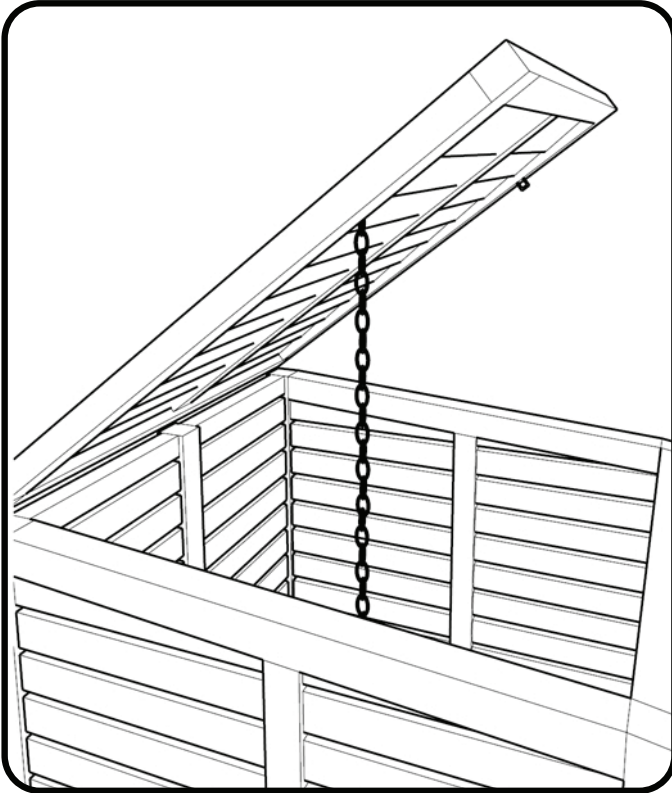

wheelie bin covers

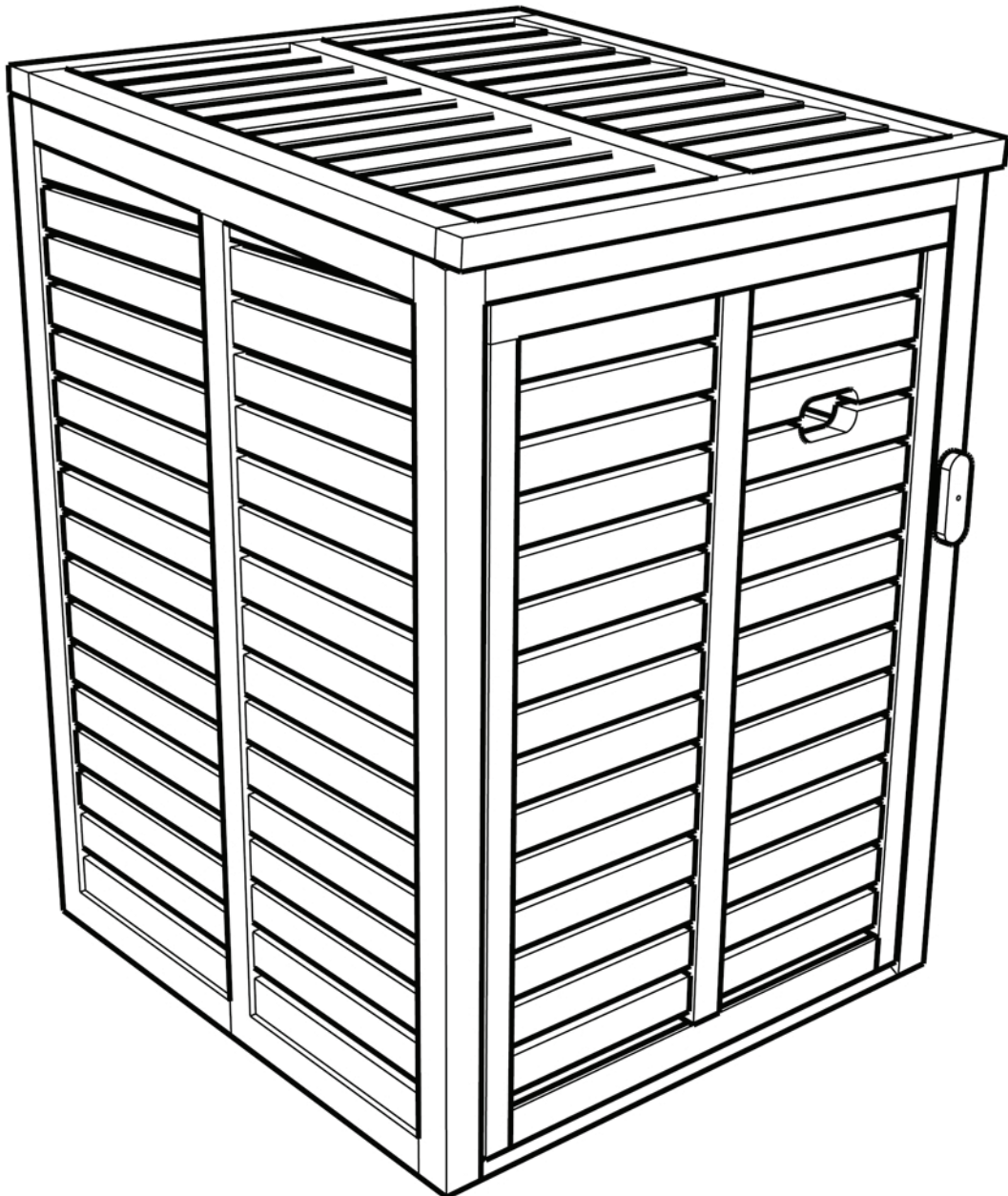

www.wheeliebincovers.co.uk